

CAST IRON V-BELT PULLEY SPA-4 ISO 4183 / DIN 2211-3

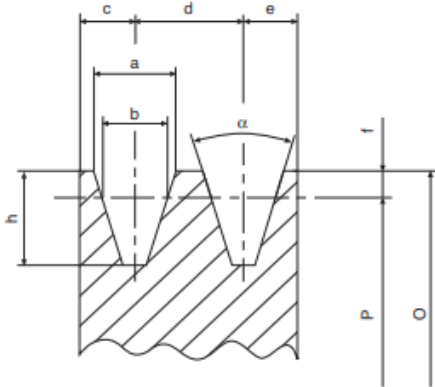

Calcolo della velocità periferica Vp in m/s
Calculation of peripheral speed Vp in m/s
Berechnung der Umfangsgeschwindigkeit Vp in m/s
Calcul de la vitesse périphérique Vp m/s
Cálculo de la velocidad periférica Vp en m/s

$$V_p = \frac{p \cdot P \cdot \text{rpm}}{60 \cdot 1000} @ \frac{P \cdot \text{rpm}}{19100} \quad V_p \leq 35 \text{ m/s}$$

P = Diametro primitivo in mm rpm = Giri al minuto
 Pitch diameter in mm Revolutions per minute
 Teildurchmesser in mm Umdrehungen pro Minute
 Diamètre primitif en mm Tours par minute
 Diámetro primitivo en mm Revoluciones por minuto

| Dimensioni puleggia | Pulley dimensions | | Keilriemenschei- benabmessungen | | | Dimensions poulie | | Dimensiones polea | |
|---------------------|-------------------|------|------------------------------------|------|------|-------------------|------|-------------------|---------|
| | a | b | c | d | e | f | h | 34° | 38° |
| SPZ | 9,7 | 8,5 | 8,0 | 12,0 | 8,0 | 2,0 | 11,0 | P ≤ 80 | P > 80 |
| SPA | 12,7 | 11,0 | 10,0 | 15,0 | 10,0 | 2,8 | 13,8 | P ≤ 118 | P > 118 |
| SPB | 16,3 | 14,0 | 12,5 | 19,0 | 12,5 | 3,5 | 17,5 | P ≤ 190 | P > 190 |
| SPC | 22,0 | 19,0 | 17,0 | 25,5 | 17,0 | 4,8 | 23,8 | P ≤ 315 | P > 315 |

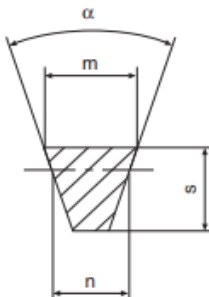

Dimensioni cinghia / Belt dimensions / Riemenabmessungen
Dimensions courroie / Dimensiones correa

| | m | s | n |
|-----|------|----|------|
| SPZ | 9,7 | 8 | 8,5 |
| SPA | 12,7 | 10 | 11,0 |
| SPB | 16,3 | 13 | 14,0 |
| SPC | 22,0 | 18 | 19,0 |

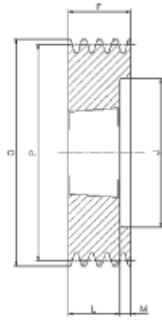

2

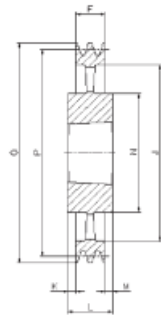

4

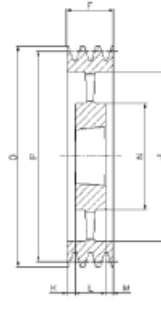

5

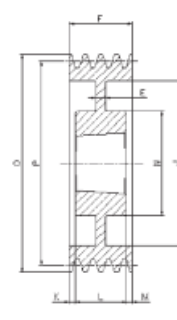

6

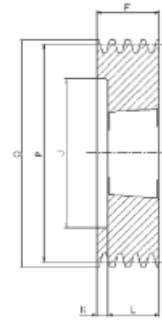

8

SPA/4

| Cod. interno Internal code Internier Code Code interne Código interno | Tipo Type Typ Type Tipo | Gole Grooves Rillen Gorges Canales | P | O | Forma Form Forme Forme Forma | Bussola Bush Buchse Moyeu Casquillo | ø MAX | E | F | J | K | L | M | N |
|---|-------------------------------------|--|------|--------|--|---|----------|----|----|-----|------|-----|------|-----|
| AT00804 | SPA 80-04 | 4 | 80 | 85,5 | 8 | 1215 | 28 | - | 65 | 49 | 27 | 38 | - | - |
| AT00904 | SPA 90-04 | 4 | 90 | 95,5 | 8 | 1615 | 42 | - | 65 | 59 | 27,0 | 38 | - | - |
| AT00954 | SPA 95-04 | 4 | 95 | 100,5 | 8 | 1615 | 42 | - | 65 | 63 | 27,0 | 38 | - | - |
| AT01004 | SPA100-04 | 4 | 100 | 105,5 | 2 | 1615 | 42 | - | 65 | 66 | - | 38 | 27,0 | - |
| AT01064 | SPA106-04 | 4 | 106 | 111,5 | 8 | 2012 | 50 | - | 65 | 72 | 33,0 | 32 | - | - |
| AT01124 | SPA112-04 | 4 | 112 | 117,5 | 8 | 2012 | 50 | - | 65 | 78 | 33,0 | 32 | - | - |
| AT01184 | SPA118-04 | 4 | 118 | 123,5 | 2 | 2012 | 50 | - | 65 | 84 | - | 32 | 33,0 | - |
| AT01254 | SPA125-04 | 4 | 125 | 130,5 | 2 | 2012 | 50 | - | 65 | 91 | - | 32 | 33,0 | - |
| AT01324 | SPA132-04 | 4 | 132 | 137,5 | 2 | 2517 | 60 | - | 65 | 98 | - | 45 | 20,0 | - |
| AT01404 | SPA140-04 | 4 | 140 | 145,5 | 2 | 2517 | 60 | - | 65 | 106 | - | 45 | 20,0 | - |
| AT01504 | SPA150-04 | 4 | 150 | 155,5 | 2 | 2517 | 60 | - | 65 | 116 | - | 45 | 20,0 | - |
| AT01604 | SPA160-04 | 4 | 160 | 165,5 | 2 | 2517 | 60 | - | 65 | 125 | - | 45 | 20,0 | - |
| AT01704 | SPA170-04 | 4 | 170 | 175,5 | 2 | 2517 | 60 | - | 65 | 135 | - | 45 | 20,0 | - |
| AT01804 | SPA180-04 | 4 | 180 | 185,5 | 2 | 2517 | 60 | - | 65 | 146 | - | 45 | 20,0 | - |
| AT01904 | SPA190-04 | 4 | 190 | 195,5 | 2 | 2517 | 60 | - | 65 | 156 | - | 45 | 20,0 | - |
| AT02004 | SPA200-04 | 4 | 200 | 205,5 | 2 | 3020 | 75 | - | 65 | 165 | - | 51 | 14,0 | - |
| AT02124 | SPA212-04 | 4 | 212 | 217,5 | 2 | 3020 | 75 | - | 65 | 177 | - | 51 | 14,0 | - |
| AT02244 | SPA224-04 | 4 | 224 | 229,5 | 2 | 3020 | 75 | - | 65 | 189 | - | 51 | 14,0 | - |
| AT02364 | SPA236-04 | 4 | 236 | 241,5 | 6 | 3020 | 75 | 25 | 65 | 202 | - | 51 | 14,0 | - |
| AT02504 | SPA250-04 | 4 | 250 | 255,5 | 6 | 3020 | 75 | 20 | 65 | 215 | 7,0 | 51 | 7,0 | 159 |
| AT02804 | SPA280-04 | 4 | 280 | 285,5 | 6 | 3020 | 75 | 25 | 65 | 245 | 7,0 | 51 | 7,0 | 159 |
| AT03004 | SPA300-04 | 4 | 300 | 305,5 | 6 | 3020 | 75 | 25 | 65 | 265 | 7,0 | 51 | 7,0 | 159 |
| AT03154 | SPA315-04 | 4 | 315 | 320,5 | 6 | 3020 | 75 | 25 | 65 | 280 | 7,0 | 51 | 7,0 | 159 |
| AT03554 | SPA355-04 | 4 | 355 | 360,5 | 5 | 3020 | 75 | - | 65 | 320 | 7,0 | 51 | 7,0 | 159 |
| AT04004 | SPA400-04 | 4 | 400 | 405,5 | 5 | 3020 | 75 | - | 65 | 365 | 7,0 | 51 | 7,0 | 159 |
| AT04504 | SPA450-04 | 4 | 450 | 455,5 | 5 | 3020 | 75 | - | 65 | 415 | 7,0 | 51 | 7,0 | 159 |
| AT05004 | SPA500-04 | 4 | 500 | 505,5 | 5 | 3020 | 75 | - | 65 | 465 | 7,0 | 51 | 7,0 | 159 |
| AT05604 | SPA560-04 | 4 | 560 | 565,5 | 4 | 3535 | 90 | - | 65 | 525 | 12,0 | 89 | 12,0 | 175 |
| AT06304 | SPA630-04 | 4 | 630 | 635,5 | 4 | 3535 | 90 | - | 65 | 595 | 12,0 | 89 | 12,0 | 175 |
| AT08004 | SPA800-04 | 4 | 800 | 805,5 | 4 | 3535 | 90 | - | 65 | 765 | 12,0 | 89 | 12,0 | 175 |
| AT10004 | SPA1000-04 | 4 | 1000 | 1005,5 | 4 | 4040 | 100 | - | 65 | 965 | 18,5 | 102 | 18,5 | 210 |